

XPRESSION 300

USER MANUAL

1 PRODUCT SPECIFICATIONS

1.1 PRODUCT SPECIFICATIONS

- ◆ Voltage: 100V-240V~, 50/60Hz
- ◆ Max Power: 300W
- ◆ Size: 485X333X322MM
- ◆ Weight: 7.8kg

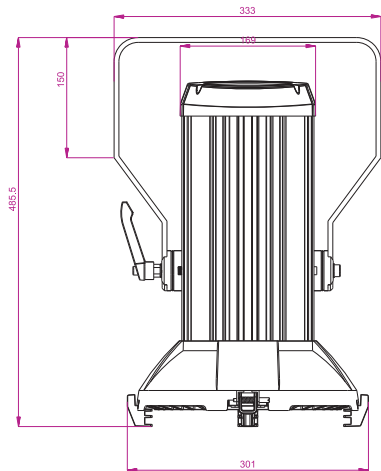
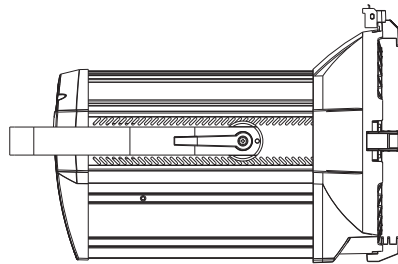
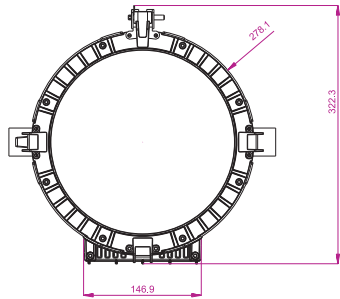

4 USING A DMX512 CONTROLLER

4.1 CHANNEL ASSIGNMENT

- Note: This product have two DMX512 channel configuration:
【 UNO 】 / 【 DOS 】 / 【 STD.P 】

UNO

CHANNEL	VALUE	FUNCTION
1	0 ⇔ 255	DIMMER

DOS

CHANNEL	VALUE	FUNCTION
1	0 ⇔ 255	DIMMER
2	0 ⇔ 255	FINE DIMMER

STD.P

CHANNEL	VALUE	FUNCTION
1	0 ⇔ 255	DIMMER
2	0 ⇔ 255	FINE DIMMER
3	0 ⇔ 9	No strobe
	10 ⇔ 99	Strobe (slow to fast)
	100 ⇔ 109	No strobe
	110 ⇔ 179	Lightning strobe (slow to fast)
	180 ⇔ 189	No strobe
	190 ⇔ 255	Random strobe (slow to fast)
4	0 ⇔ 255	ZOOM
5	0 ⇔ 200	NO FUNCTION
	201 ⇔ 220	Motor reset
	221 ⇔ 255	NO FUNCTION

1.2 SAFETY WARNING

IMPORTANT:

- This product must be installed by a qualified professional.
- All maintenance must be carried out by a qualified electrician.
- A minimum distance of 0.5m must be maintained between the equipment and a combustible surface.
- The product must always be operated in a well ventilated area.
- DO NOT stare directly into the LED light source.
- Always disconnect the power before carrying out any maintenance.
- The earth must always be connected to the ground.
- Ensure that all parts of the equipment are kept clean and free of dust.
- A minimum distance of 0.8m must be maintained between the light and projecting surface



Caution, risk of electric shock
The light source contained in this luminaire shall only be replaced by the manufacturer or his service agent or a similar qualified person.

2 INSTALLATION

2.1 MOUNTING

HANGING

The LED fixture can be mounted in a hanging position using the supporting bracket. The bracket should be secured to the mounting truss or structure using a standard mounting clamp. Please note that when hanging the unit a safety cable should also be used.

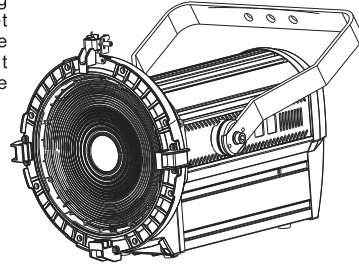

2.2 POWER CONNECTIONS

- 220~240V: 8 units may be connected in series
- 110~120V: 4 units may be connected in series

CURV dimming

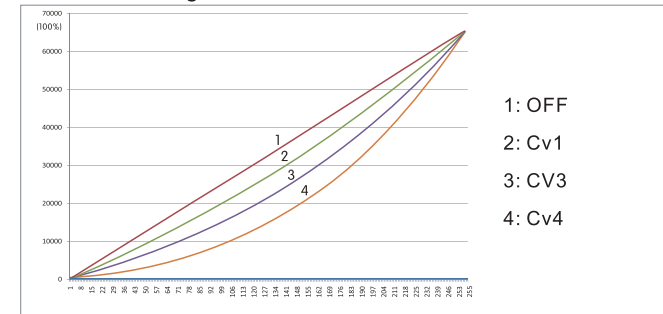

3.9 WHITES CALIBRATION(CAL)



- Enter the [CAL] to select white color of different color temperature.
- Select the [ZOOM] range. [POS1] & [POS2] set the small position for the zoom function. Note that when using DMX to control the fixture, the user will only be able to access up to the set ZOOM position. It is not possible to adjust beyond the set position.

3.8 SPECIAL SETTINGS

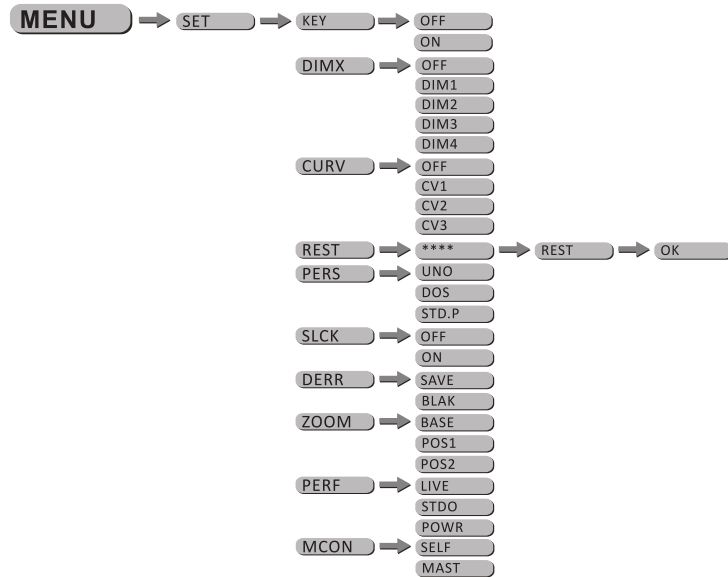

- [SET]...this menu allows the user to adjust key operation settings for this fixture.
[KEY]...select [ON] for automatic lock-out. Password to re-enter the display is <UP> + <DOWN> + <UP> + <DOWN>.
- Select [DIM1], [DIM2], [DIM3] or [DIM4] for different dimming speeds. ([DIM4] is the slowest dimming speed)
- [CURV] allows the user to adjust the shape of the dimming curve. See the CURV chart to understand more about actual dimming curves.
- In order to reset custom modes to default values select [REST].
- [PERS]...this setting allows the user to select the DMX personality of the fixture. Refer to DMX personality charts for specific details.
- [SLCK] is used to lock the settings menu. When [SLCK] is set to [ON] then user must insert passcode (UP+DOWN+UP+DOWN) in order to access the settings menu.
- [DERR] Choose [Save] in order to save the last DMX data in case of DMX signal error.
Choose [Black] in order to blackout in case of DMX signal error.
- <ZOOM> is for setting zoom, press UP/DOWN to select. <BASE> is standard setting;
<POS1> is zoom setting 1; <POS2> is zoom setting 2. Press MENU to get back, and the setting is saved automatically.
- [PERF] this setting allows the user to select the performance characteristics of the fixture.
- [MCON]...this function allows the user to select whether the fixture will send DMX data to other fixtures during stand-alone operation. The [MAST] setting allows data to be sent to other fixtures. The [SELF] setting is default and will not send DMX data to other fixtures.

3 DISPLAY PANEL OPERATION

3.1 DISPLAY OPERATION

【 MENU 】 return to the previous menu.

【 ENTER 】 enter the currently selected menu.

【 UP 】 scroll down through the current menu list or decrease the value of the current function.

【 DOWN 】 scroll up through the current menu list or increase the value of the current function.

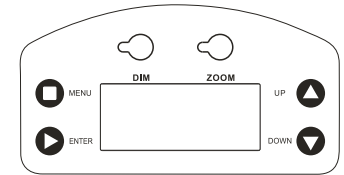

QUICK-ACCESS KEYS

【 MENU 】 By press and holding the [MENU] key when at the main menu it is possible to directly access the [DIM] function

3.2 CONTROL KNOB

- . DIMMER
- . ZOOM

Notes:

- Press the adjusting button (any one) twice, the fixture will be in STAT mode;
- Press the DIMMER button, DIM shows in the menu, the value range is 0—100%;
- Press ZOOM button, value range 0—100% appears

3.3 MENU MAP

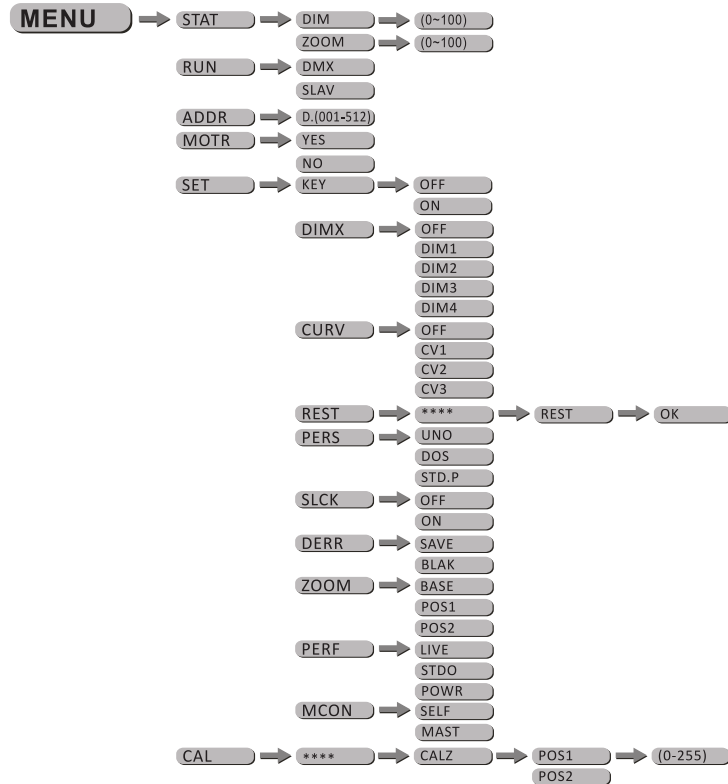

3.4 DIMMER (STAT)



- [DIM]...to adjust level of intensity
- [ZOOM]...to adjust the zoom position

Note: When using this function, if the [MCON] menu is set as [MAST], then the fixture will transfer the [DIM] values to other fixtures. ii) When DMX data is received at the fixture, it will automatically return to main menu after 2 minutes of no key operation.

3.5 RUN MODE



- [RUN]...this menu allows the user to select the operating mode of the fixture. Select [DMX] for normal DMX operation or [SLAV] for slave operation.

3.6 DMX ADDRESS



- [ADDR]...this menu allows the user to select the start address of the fixture. Use <UP> or <DOWN> keys to select required start address.

3.7 Motor reset(MOTR)



- Press ENTER to enter < MOTR >
- Press UP/DOWN and select <YES> or <NO>
- When you select < YES > and press ENTER, the motor will be reset to origin
- When you select <NO>, and press ENTER, no control.